

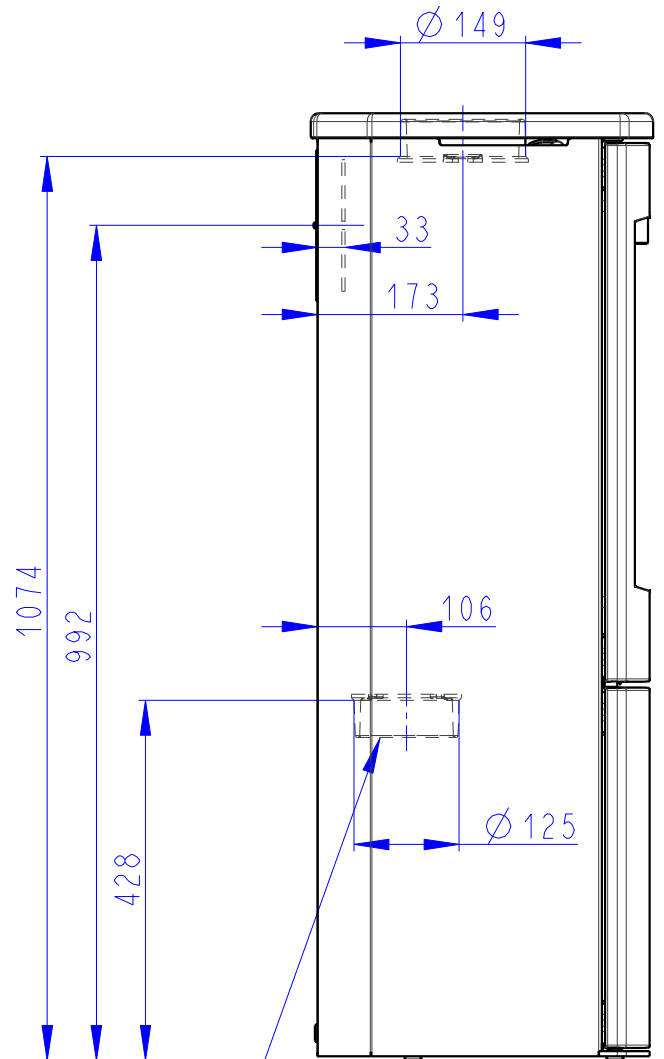

# NEMEA 01

PLATEAU EN CÉRAMIQUE  
TOPPLATTE KERAMIK  
TOP PLATE CERAMICS

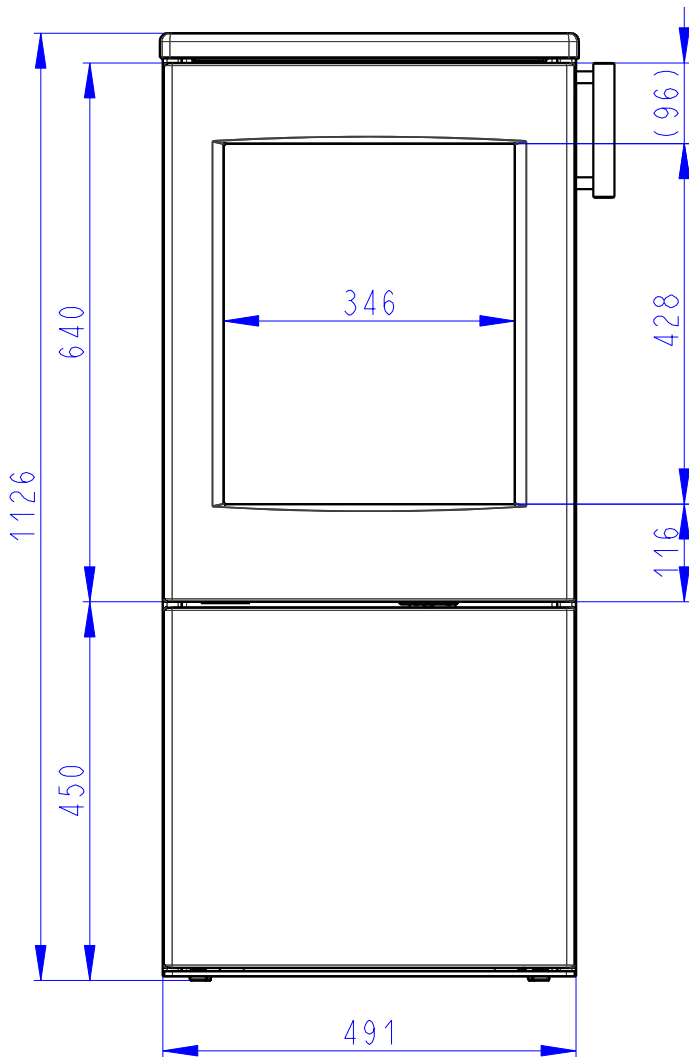

Arrivée d'air central  
Zentralluftzufuhr  
Central air inlet

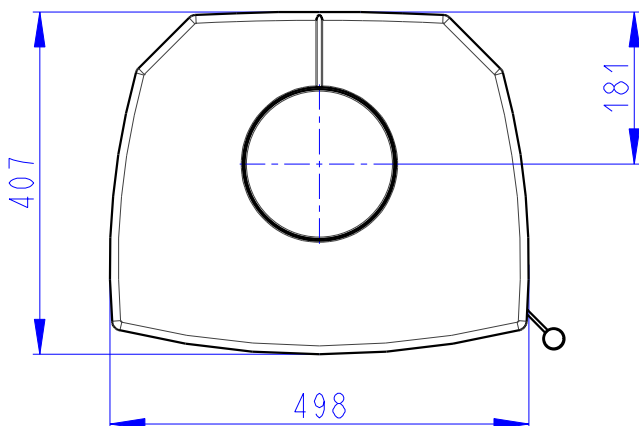

Air primaire  
Air secondaire  
Air tertiaire  
Primärluft  
Sekundärluft  
Tertiärluft  
Primary air  
Secondary air  
Tertiary air

